



Primary Switched Battery Charging & Power Supply

GL10024P

3-phase -2400 W

**Input**

Nominal voltage	3× AC 400–500 V
Operation voltage range	AC 340 V–550 V/DC 520 V–750 V
Line frequency	47 Hz – 63 Hz
Rated current	U <sub>i</sub> = AC 400 V: 4.5 A / U <sub>i</sub> = AC 500 V: 3.5 A
Inrush current	<AC 10 A (active inrush current limitation)
External fuse	Automatic: 3 × C 10 A (mandatory)
Power Factor Correction P.F.C.	>0.92
Input protection	Surge protection according to VDE 0160, over/undervoltage (auto restart) Phase monitoring (reduced output power): PFC error

**Load Side**

Rated voltage output	DC 24 V
Rated current output	100 A
Max. output current	>150 A, 5 s, with U <sub>out</sub> >90 %
Short-circuit current	150 A, 5 s
Low power loss	<200 W
Voltage trim range	DC 11.5–29 V
Load regulation	<1 %
Rise time	< 4.5 S
Ripple & Noise	<200 mV

## Technical data sheet • Power supply

Hold up time	>10 ms (AC 400 V); >10 ms (AC 500 V)
Status indication DC ON LED green	alphanumeric display
Status indication DC LOW LED red	alphanumeric display
Parallel/redundant operation	max. 4 devices
Efficiency	>92 %
Over voltage protection	>30 V
Short circuit characteristics	adjustable: Hiccup, current limiting

### General

Insulation voltage input/output	AC 3.0 kV <sub>eff</sub>
Insulation voltage input / ground	AC 1.5 kV <sub>eff</sub>
Insulation voltage output / ground	AC 0.5 kV <sub>eff</sub>
Operation temperature range	-20 °C – 60 °C (derating)
Derating	>45 °C: -40 W/°C
Storage temperature range	-25 °C – 85 °C
M.T.B.F.	>500000 h to SN29500 / >150000 h to MIL standard HDBK 217F
Dimensions (w × h × d)	233.0 × 158.0 × 102.0 mm
Cooling	Natural air cooling, forced cooling >45 °C, 80 mm distance top/bottom, 10 mm side
Installation position	vertical
Housing material	Aluminium
Protection class	IP 20 (IEC529, EN60529)
Field installation	rail TS 35 (EN 50022)
IP rating	I (SELV, PELV)
Overvoltage category	II
Pollution degree	2
Weight (kg/piece)	2.800
Termination	Screw connection: input 0.2–4.0 mm <sup>2</sup> /output 0.2–35 mm <sup>2</sup> /auxiliary 0.2–1.5 mm <sup>2</sup>
Approvals	Standards: UL 508, IEC 950, EN 60950, EN 55011 CE: EN 61000-4-5, Surge immunity level IV, VDE 0160 CE: EN 61000-4-2/3/4/5/6/11

### Monitoring

DC ON Control (Rdy)	Relay, N/O contact active, adjustable, DCok: 90–110 % Uset, ACok: acc. input voltage range, overload Overtemperature range, charging complete
Switching capacity	AC/DC 30 V, 1 A, 30 W
Insulation voltage	AC 500 V
Output current	galvanically isolated: 0–10 V and 4–20 mA

### Interface

User Interface	LCD display 16 × 2 character, multi language, 4 keys (command and navigation)
Auxiliary voltage output	galvanically isolated DC 12 V, 100 mA

## Technical data sheet • Power supply

NTC

Temperature-controlled battery charging (mandatory)

### Dimensions

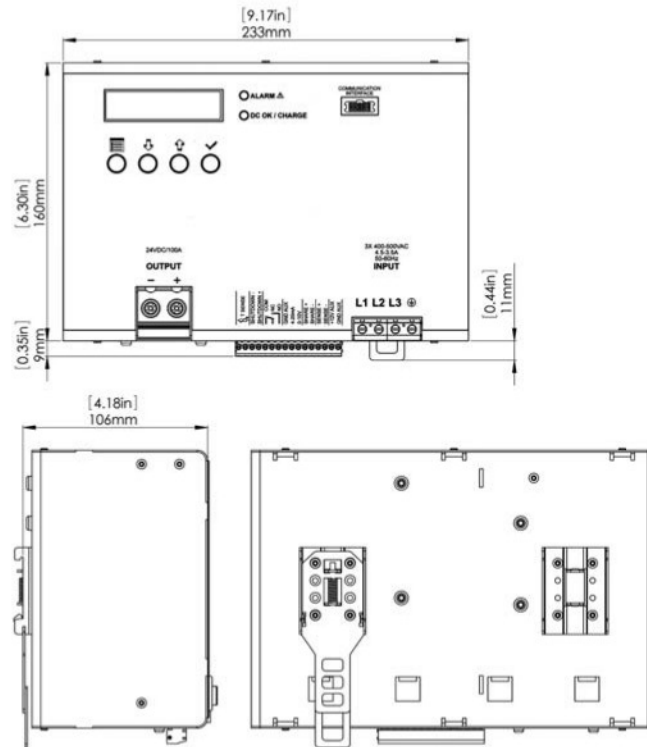

# Technical data sheet • Power supply

## PIN assignment

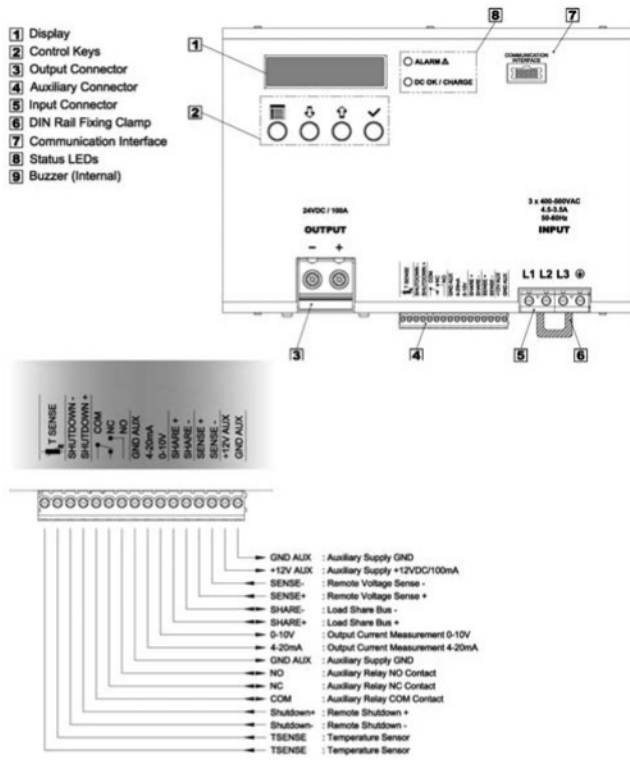

## Parallel/redundant mode

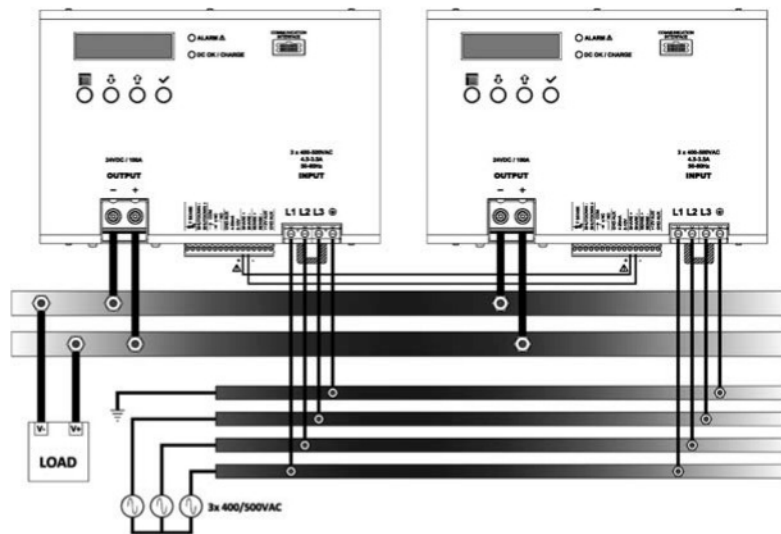

**Technical data sheet** · Power supply

**Serial operation**

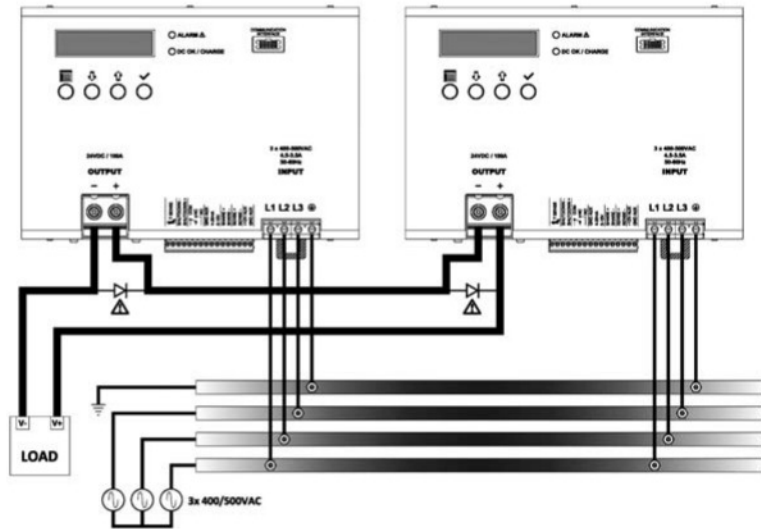

**Charging operation**

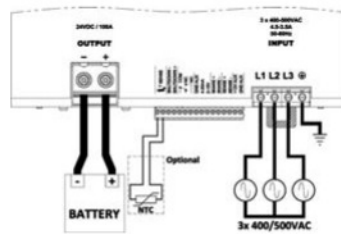

**Output voltage in 0–10 V**

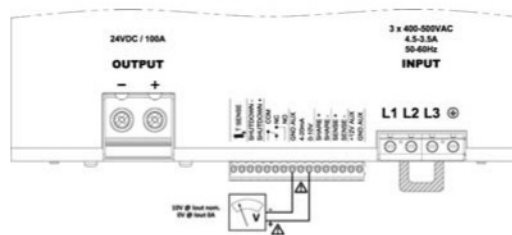

**Output voltage in 4–20 mA**

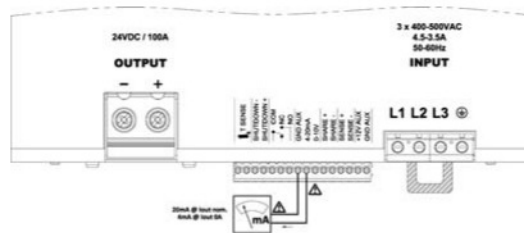

## Technical data sheet • Power supply

### Range of functions

The new power compact series provides a number of additional adjustment options via function keys. The selected functions are shown on a display. In addition, the current output voltage and current are displayed for normal operation.

#### Input protection

- Active Surge suppressor and inrush limiter (ASSIL) as protection against over-voltages according to VDE 0160
- PFC error monitoring
- Phase monitoring with automatic reduction of the output power
- Automatic start/restart system for over- and undervoltages

#### Output protection

- Adjustable current limiting between  $0.1 I_N$  and  $I_N$
- Hiccup autoreset based on current limiting or maximum output voltage (150%)

#### Status display and signal

- In addition to an LED for "DC OK" and error displays, the devices have the following analog outputs 0–10 V and 4–20 mA as direct function of the load current
- Programmable relay contact with the functions
  - Output voltage/current,
  - Overload,
  - Overtemperature

#### Additional functions

- Temperature-compensated battery charging function
- Display and compensation of the voltage drop for long cables
- Remote On/Off of the output voltage
- DC 12 V auxiliary voltage
- Monitoring and control interface based on RS232 (optional)
- Integrierte O-Ring-Diode
- Load sharing in parallel operation
- Load current sharing